



PANEL BLINDS

ABSOLUTE | ULTIMATE

| From innovative functionality
to ultimate design

coulisse®

Disclaimer

© Copyright Coulisse

All rights reserved. No part of this publication may be reproduced, stored in a retrieval system, or transmitted, in any form, by any means, electronic, mechanical, photocopying, recording, digital or otherwise without the written permission of the publisher. Although this publication has been composed with the utmost care, Coulisse B.V. does not accept any responsibility for damage due to mistakes and/or faults in this publication. Coulisse B.V. reserves the right to revise this publication and to revise and/or change its content at any time, without obligation to notify any person or entity of such revisions or changes. The most recent version replaces older versions of this publication. The most recent version is available at the Coulisse customer portal or your Coulisse contact. Please send your remarks and/or comments about this publication to info@coulisse.com.

Version: 2012_R1_GB1

INDEX

General information	4
Highlight	5
Motorisation	6
System specifications	8
Configurations	14
Parts lists	16
Collections	32
Documentation	34
Service and support	34
Company profile	35



GENERAL INFORMATION

For panel blinds Coulisse offers two system types. Absolute Panel Blind is characterized by easy assembly and user friendliness. The technical features that are incorporated into the design make it exceptional. Apart from easy installation of the panels, the self-correcting stoppers make sure the panels are positioned straight behind one another when the blind is completely open. With the unique panel blind motor the system furthermore can easily be motorized. Ultimate Panel Blind is a unique free-hanging panel blind system with a contemporary designer look. The rail is provided with design brackets and invisible sliding profiles. The technique is based on the Absolute system.

ADVANTAGES

- PVC sliding profile for use of Velcro as well as hold-down strip
- Stoppers can easily be replaced without having to deinstall the blind
- Self-correcting stoppers
- Invisible rail connector for easy transportation of rail
- Window cleaning function
- Panels reach end of the window frame
- No light fissure between rail and panels
- Available in different colours and finishes
- Unique cord system
- Panels positioned exactly behind one another
- Ultimate design system available
- Unique in the market: panel blind motor



UNIQUE HOOKING SYSTEM

The patented hooking system makes it easy to attach the panels even after installation of the rail. The sliding profiles are suitable for the use of Velcro as well as hold-down strip.

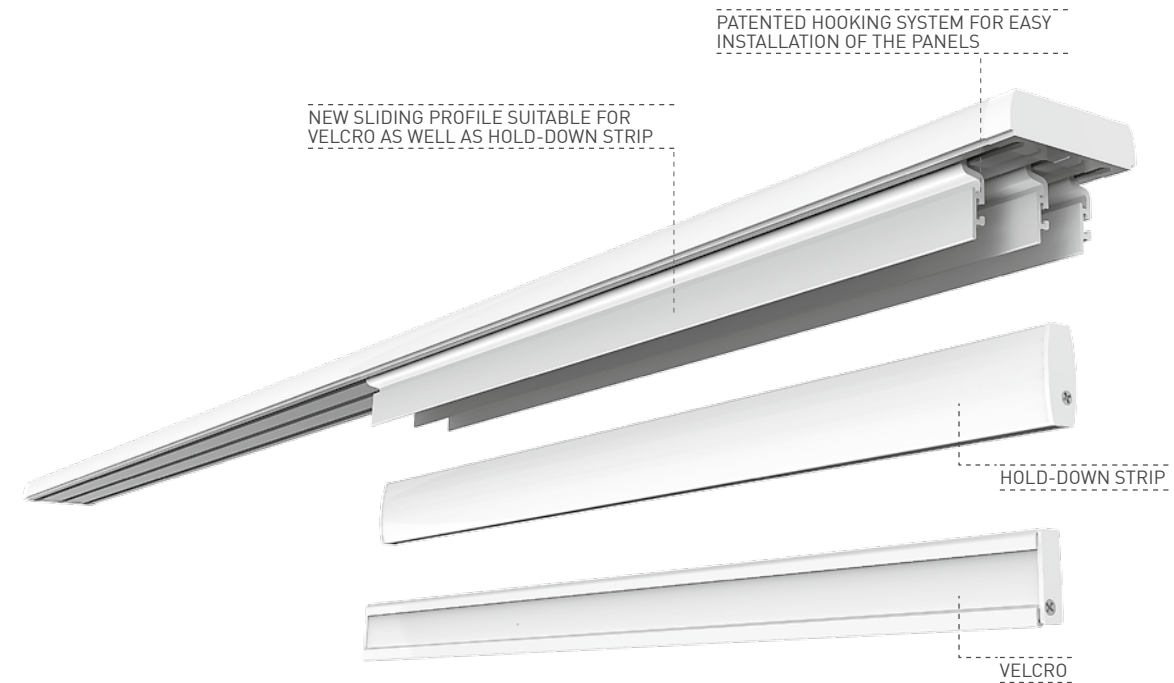

PANEL BLIND MOTOR

The Coulisse panel blind motor can be installed on the rail in an optically attractive way. The motor is easy to install, program and operate. The panel blind motor is part of the Absolute Control range for the automation of blinds. The system is characterized by easy and wireless programming and operation from a distance. All motors can be operated with a single remote control. With the Coulisse Solar Strip - a plug and play power supply that works on solar energy - the system is completely wireless.

ADVANTAGES

- Unique in the market
- Compatible with Coulisse Absolute Panel Blind system
- Suitable for configurations: split-draw left and right
- Power supply options: battery, solar or transformer
- RF module integrated into the motor
- Patented driving technique
- Speed control
- Intelligent motor: self-learning, safety check, auto reset
- Voltage range of in between 12-24VDC
- Silent operation



SYSTEM SPECIFICATIONS

Absolute Panel Blind

Panel width (cm)	Number of runners
0-700	2
701-1100	3
1101-1500	4

Maximum weight per runner is 1,0 kg

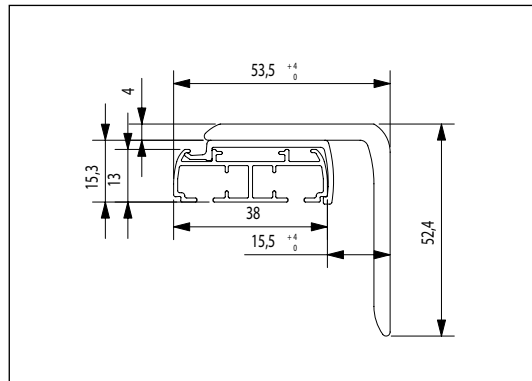

2- WAY

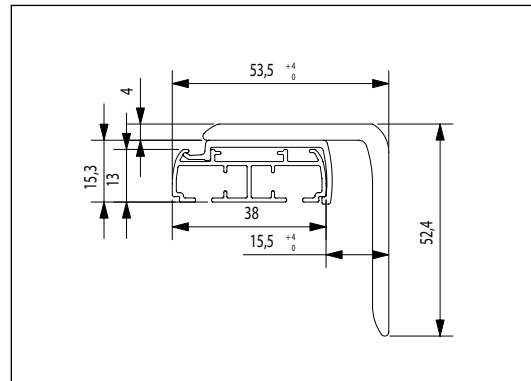

3- WAY

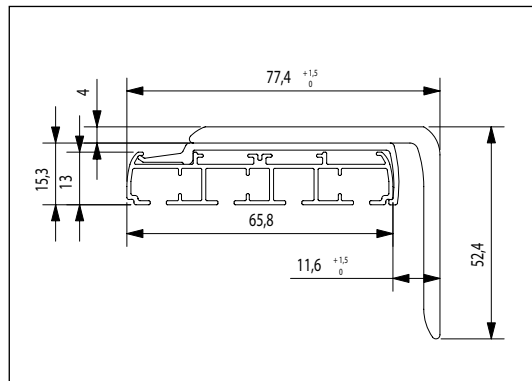

4- WAY

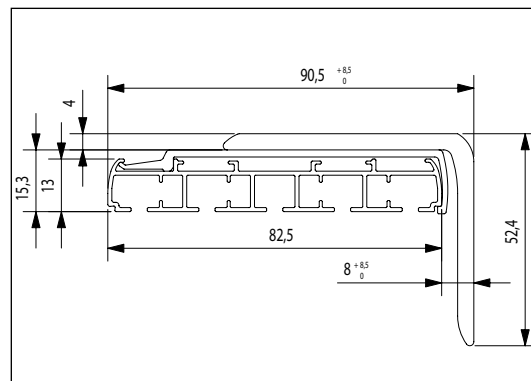

5- WAY

Absolute Panel Blind Motorized

Power supply	12-24V DC - 0,6 A
Rated power	7 W
Chain speed	3,75 mtr/min
Max. pulling force	30 N
Max. weight panel blind	15 kg
Operating temperature	5 - 60°C
Max. channels to pair	32
Weight	220 grams
Radio frequency	2.4 Ghz (bi-directional)
Number of tracks	3,4,5
Suitable for home automation	Yes

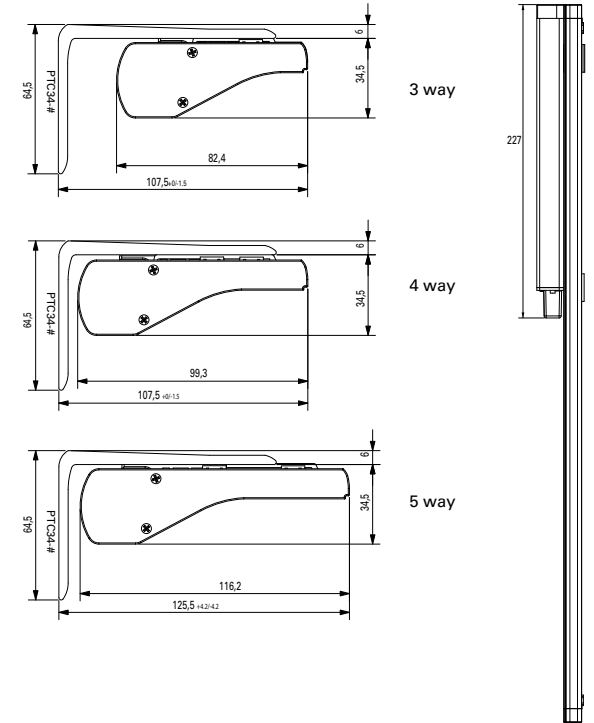

Number of clips

W (mm)	Number of ceiling clips
-1000	2
1000-1800	3
1800-2600	4
3400-4200	5
5000-5800	6

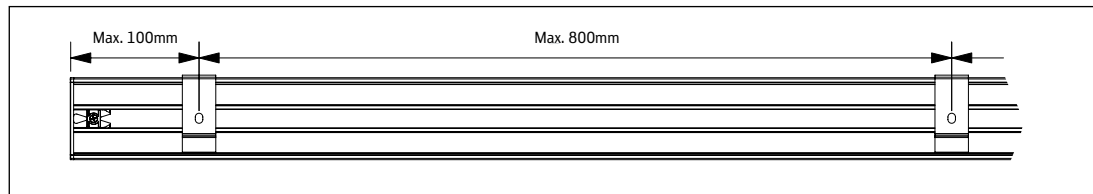

Connect head rails with connector clip PTC33C2, PTC33C3, PTC33C4 or PTC33C5

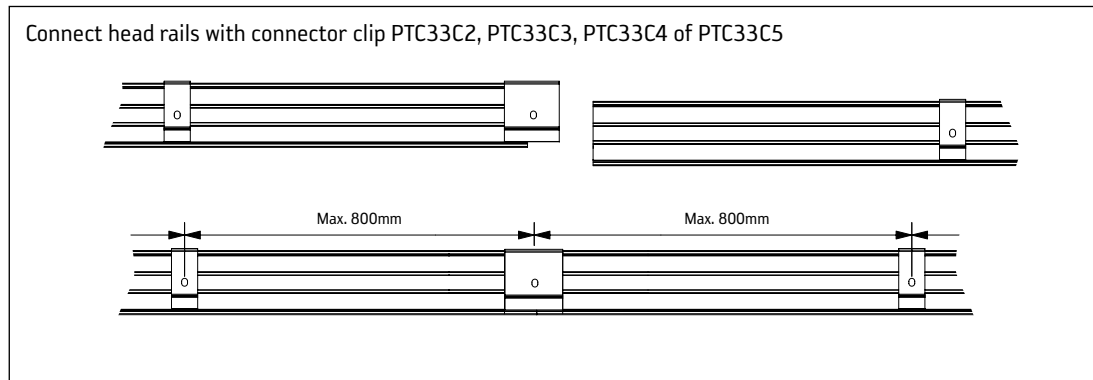

SYSTEM SPECIFICATIONS

Ultimate Panel Blind

Panel width	Number of runners
0-700	2
701-1100	3
1101-1500	4

Maximum weight per runner is 1,0 kg

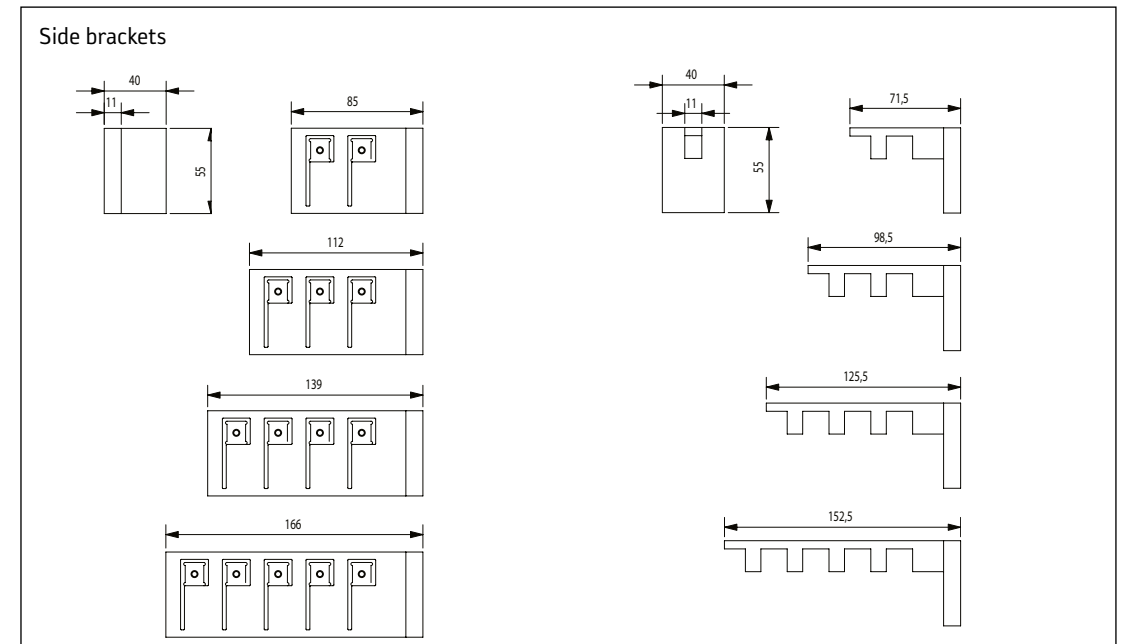

Ceiling brackets with end caps

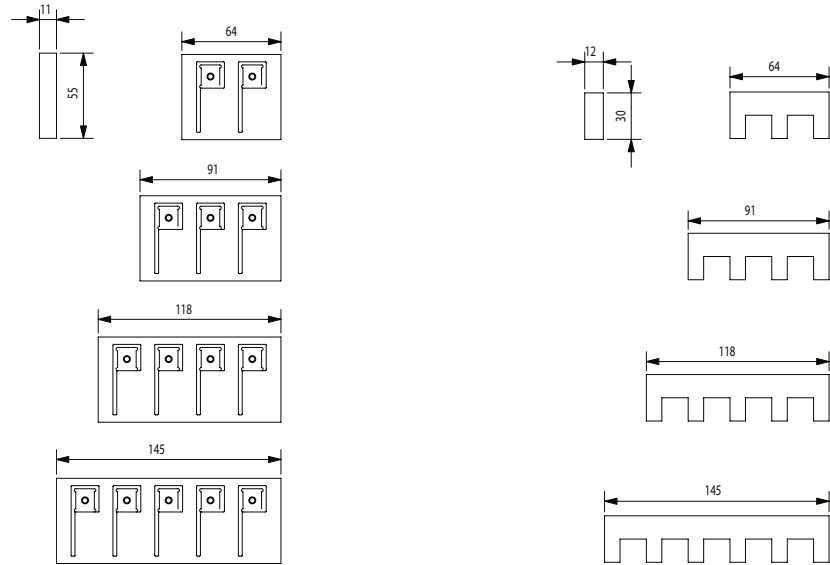

Wall brackets with end caps

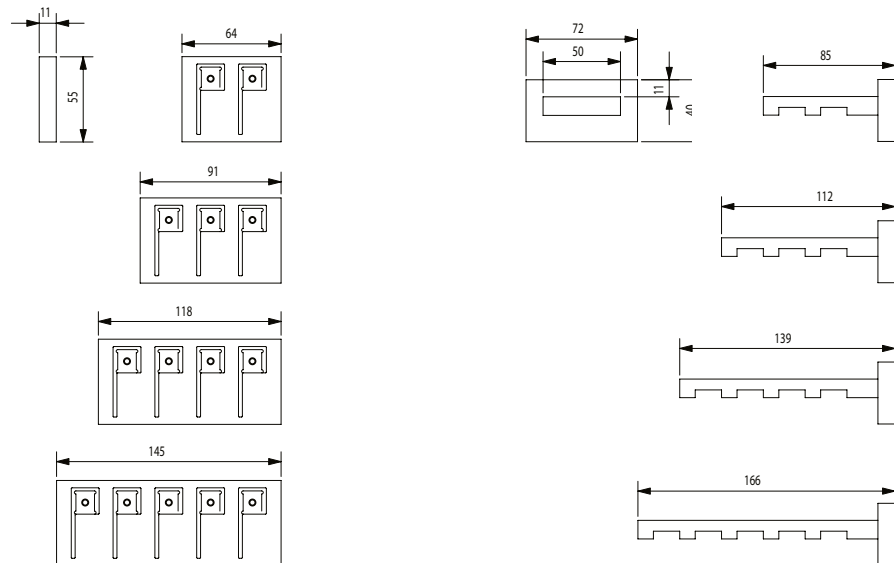

Number of brackets

Number of brackets	Max. width side brackets	Max. width ceiling and wall brackets
2	1000	1200
3	2000	2000
4	3000	2800
5	4000	3600
6	5000	4400
7	5800	5200
8	-	5800

Configuration: Side brackets

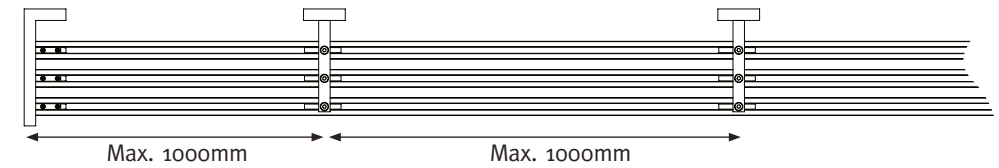

Configuration: Ceiling and wall brackets

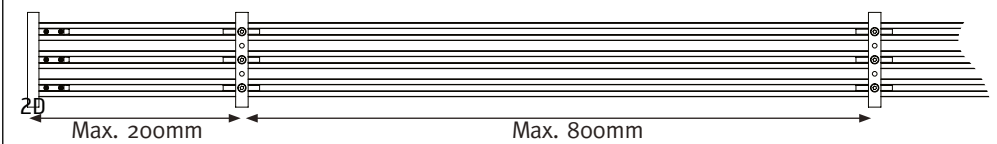

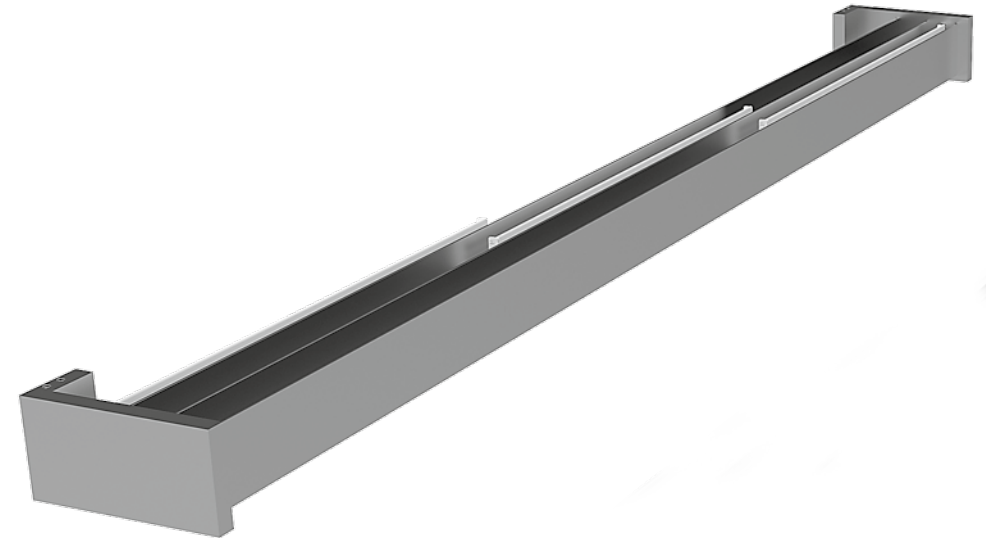

- 1** Absolute Panel Blind
- Hold-down strip
 - Velco
 - Cord control
 - Wand control

- 2** Absolute Panel Blind
motorized



- 3** Ultimate Panel Blind
- Side bracket
 - Wall bracket with end cap
 - Ceiling bracket with end cap

PARTSLIST
 Absolute Panel Blind
 hold-down strip / cord control

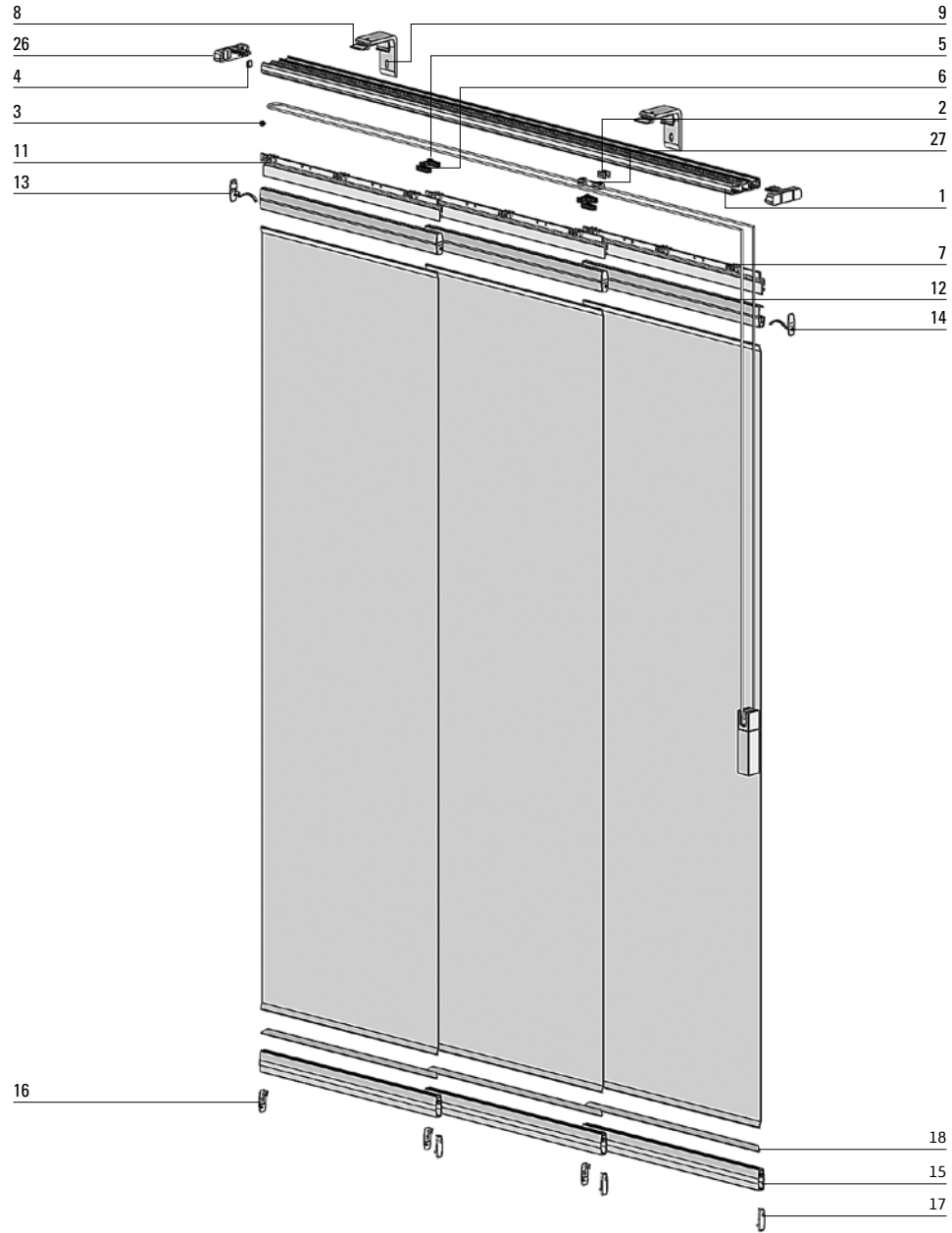



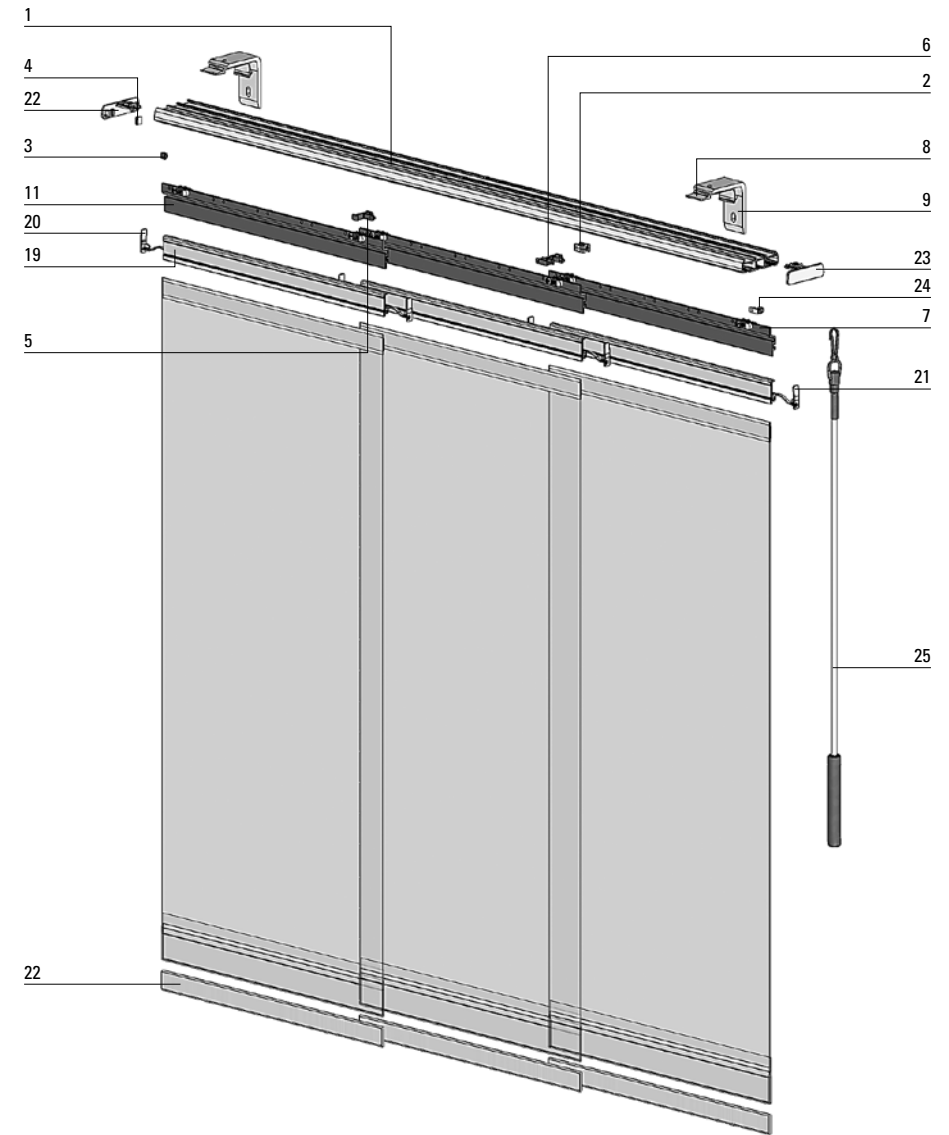







PARTSLIST
 Absolute Panel Blind
 velcro / wand control

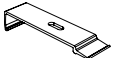

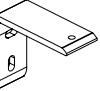
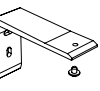



ABSOLUTE PANEL BLIND



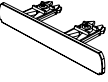

Pos	Code	Description	Inner Carton	Outer Carton	
1	PTC21-W	Track 2-way 580cm white	69,6 mtr/Carton	69,6 mtr/Carton	
	PTC21-S	Track 2-way 580cm grey	69,6 mtr/Carton	69,6 mtr/Carton	
1	PTC22-W	Track 3-way 580cm white	69,6 mtr/Carton	69,6 mtr/Carton	
	PTC22-S	Track 3-way 580cm grey	69,6 mtr/Carton	69,6 mtr/Carton	
1	PTC23-W	Track 4-way 580cm white	69,6 mtr/Carton	69,6 mtr/Carton	
	PTC23-S	Track 4-way 580cm grey	69,6 mtr/Carton	69,6 mtr/Carton	
1	PTC24-W	Track 5-way 580cm white	69,6 mtr/Carton	69,6 mtr/Carton	
	PTC24-S	Track 5-way 580cm grey	69,6 mtr/Carton	69,6 mtr/Carton	
2	PTC18-W	Mid-stopper white	500 pcs/Bag	5000 pcs/Carton	
	PTC18-S	Mid-stopper grey	500 pcs/Bag	5000 pcs/Carton	
3	PTC31	Metal clip	500 pcs/Bag	5000 pcs/Carton	
4	PTC32	Magnet	500 pcs/Bag	5000 pcs/Carton	
11	PTC20VH-W	Sliding profile PVC 300cm white	120 mtr/Carton	120 mtr/Carton	
	PTC20VH-S	Sliding profile PVC 300cm grey	120 mtr/Carton	120 mtr/Carton	
5	PTC01H-W	T-stopper white	500 pcs/Bag	5000 pcs/Carton	
	PTC01H-S	T-stopper grey	500 pcs/Bag	5000 pcs/Carton	
6	PTC03H-W	L-stopper white	500 pcs/Bag	5000 pcs/Carton	
	PTC03H-S	L-stopper grey	500 pcs/Bag	5000 pcs/Carton	
7	PTC04-W	Runner white	500 pcs/Bag	5000 pcs/Carton	

Pos	Code	Description	Inner Carton	Outer Carton	
/	PTC35-W	Base plate white			
8	PTC17C2-W	One-side clip 2-way white	200 pcs/Bag	1000 pcs/Carton	
	PTC17C2-S	One-side clip 2-way grey	200 pcs/Bag	1000 pcs/Carton	
8	PTC17C3-W	One-side clip 3-way white	200 pcs/Bag	1000 pcs/Carton	
	PTC17C3-S	One-side clip 3-way grey	200 pcs/Bag	1000 pcs/Carton	
8	PTC17C4-W	One-side clip 4-way white	200 pcs/Bag	1000 pcs/Carton	
	PTC17C4-S	One-side clip 4-way grey	200 pcs/Bag	1000 pcs/Carton	
8	PTC17C5-W	One-side clip 5-way white	200 pcs/Bag	1000 pcs/Carton	
	PTC17C5-S	One-side clip 5-way grey	200 pcs/Bag	1000 pcs/Carton	
9	PTC17WB-23-W	Wall bracket small white	50 pcs/Bag	500 pcs/Carton	
	PTC17WB-23-S	Wall bracket small grey	50 pcs/Bag	500 pcs/Carton	
9	PTC17WB-45-W	Wall bracket medium white	50 pcs/Bag	500 pcs/Carton	
	PTC17WB-45-S	Wall bracket medium grey	50 pcs/Bag	500 pcs/Carton	
9	PTC34	Wall bracket large white	50 pcs/Bag	500 pcs/Carton	
/	PTC33C2-W	Connector clip 2-track white	100 pcs/Bag	500 pcs/Carton	
	PTC33C2-S	Connector clip 2-track grey	100 pcs/Bag	500 pcs/Carton	
/	PTC33C3-W	Connector clip 3-track white	100 pcs/Bag	500 pcs/Carton	
	PTC33C3-S	Connector clip 3-track grey	100 pcs/Bag	500 pcs/Carton	
/	PTC33C4-W	Connector clip 4-track white	100 pcs/Bag	500 pcs/Carton	
	PTC33C4-S	Connector clip 4-track grey	100 pcs/Bag	500 pcs/Carton	
/	PTC33C5-W	Connector clip 5-track white	100 pcs/Bag	500 pcs/Carton	
	PTC33C5-S	Connector clip 5-track grey	100 pcs/Bag	500 pcs/Carton	

Pos	Code	Description	Inner Carton	Outer Carton	
12	PTC28VH-W	Top profile for hold down strip 300cm white	120 mtr/Carton	120 mtr/Carton	
	PTC28VH-S	Top profile for hold down strip 300cm grey	120 mtr/Carton	120 mtr/Carton	
13	PTC30AN-W	End cap for hold down strip left white	500 pcs/Bag	5000 pcs/Carton	
	PTC30AN-S	End cap for hold down strip left grey	500 pcs/Bag	5000 pcs/Carton	
14	PTC30BN-W	End cap for hold down strip right white	500 pcs/Bag	5000 pcs/Carton	
	PTC30BN-S	End cap for hold down strip right grey	500 pcs/Bag	5000 pcs/Carton	
15	PTC25-W	Bottom rail 300cm white	120 mtr/Carton	120 mtr/Carton	
	PTC25-S	Bottom rail 300cm grey	120 mtr/Carton	120 mtr/Carton	
16	PTC30A-W	End cap strip left white	500 pcs/Bag	5000 pcs/Carton	
	PTC30A-S	End cap strip left grey	500 pcs/Bag	5000 pcs/Carton	
17	PTC30B-W	End cap strip right white	500 pcs/Bag	5000 pcs/Carton	
	PTC30B-S	End cap strip right grey	500 pcs/Bag	5000 pcs/Carton	
18	RBR-F-S8-AH	Hold down strip adhesive 8mmx0.4mm	500 mtr/Roll	2000 mtr/Carton	
19	PTC28V-W	Panel profile with velcro 300cm white	120 mtr/Carton	120 mtr/Carton	
	PTC28V-S	Panel profile with velcro 300cm grey	120 mtr/Carton	120 mtr/Carton	
20	PTC26VL-W	End cap velcro left white	500 pcs/Bag	5000 pcs/Carton	
	PTC26VL-S	End cap velcro left grey	500 pcs/Bag	5000 pcs/Carton	
21	PTC26VR-W	End cap velcro right white	500 pcs/Bag	5000 pcs/Carton	
	PTC26VR-S	End cap velcro right grey	500 pcs/Bag	5000 pcs/Carton	
22	PTB25-W-300	Bottom rail 300cm white	108 mtr/Carton	108 mtr/Carton	

Pos	Code	Description	Inner Carton	Outer Carton	
23	PTC11-W	End cap with screw 2-way white	500 pcs/Bag	5000 pcs/Carton	
	PTC11-S	End cap with screw 2-way grey	500 pcs/Carton	5000 pcs/Carton	
23	PTC12-W	End cap with screw 3-way white	500 pcs/Carton	5000 pcs/Carton	
	PTC12-S	End cap with screw 3-way grey	500 pcs/Carton	5000 pcs/Carton	
23	PTC13-W	End cap with screw 4-way white	500 pcs/Carton	2000 pcs/Carton	
	PTC13-S	End cap with screw 4-way grey	500 pcs/Carton	2000 pcs/Carton	
23	PTC14-W	End cap with screw 5-way white	250 pcs/Carton	1500 pcs/Carton	
	PTC14-S	End cap with screw 5-way grey	250 pcs/Carton	1500 pcs/Carton	
24	PTC05-W	Eyelet for wand control white	500 pcs/Bag	5000 pcs/Carton	
	PTC05-S	Eyelet for wand control grey	500 pcs/Bag	5000 pcs/Carton	
/	PTC06-W	Drive runner for wand control white	200 pcs/Bag	4000 pcs/Carton	
	PTC06-S	Drive runner for wand control grey	200 pcs/Bag	4000 pcs/Carton	
25	PT26-W	Wand panel blind 114cm white	50 pcs/Carton	50 pcs/Carton	
	PT26-S	Wand panel blind 114cm silver	50 pcs/Carton	50 pcs/Carton	

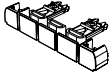



PARTSLIST

Pos	Code	Description	Inner Carton	Outer Carton	
26	PTC07-W	End cap cord 2-way white	250 pcs/Carton	2000 pcs/Carton	
	PTC07-S	End cap cord 2-way grey	250 pcs/Carton	2000 pcs/Carton	
26	PTC08-W	End cap cord 3-way white	250 pcs/Carton	1500 pcs/Carton	
	PTC08-S	End cap cord 3-way grey	250 pcs/Bag	1500 pcs/Carton	
26	PTC09-W	End cap cord 4-way white	100 pcs/Carton	1000 pcs/Carton	
	PTC09-S	End cap cord 4-way grey	100 pcs/Bag	1000 pcs/Carton	
26	PTC10-W	End cap cord 5-way white	100 pcs/Bag	800 pcs/Carton	
	PTC10-S	End cap cord 5-way grey	100 pcs/Carton	800 pcs/Carton	
27	PTC15-W	Cord connector runner white	500 pcs/Bag	5000 pcs/Carton	
/	PTC29-W	Cord drive runner loop white	500 pcs/Bag	5000 pcs/Carton	

CORD

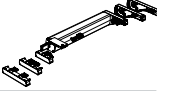
ADDITIONALPARTSLIST
Motorized

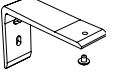
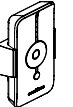
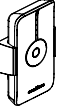
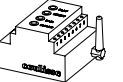
MOTORIZED

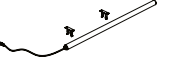
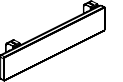
Pos	Code	Description	Inner Carton	Outer Carton	
	ABC-04-LW	Panel blind motor left white	1 pcs/Carton	30 pcs/Carton	
	VC14-P	Pulling chain for mono control white	250 mtr/Carton	2000 mtr/Carton	
	PTC34	Wall bracket large white	50 pcs/Bag	500 pcs/Carton	
/	ABC-01-W	Remote made to measure inclusive holder white	1 set/Carton	80 set/Carton	
	ABC-01-S	Remote made to measure inclusive holder silver	1 set/Carton	80 set/Carton	
/	ABC-20-W	One-channel remote control white	1 set/Carton	80 set/Carton	
/	ABC-19	Domotica box	1 pcs/Carton	1 pcs/Carton	
/	ABC-11-W	Adaptor 1.5A - 12V DC 100V-240V AC white	1 pcs/Carton	50 pcs/Carton	
/	ABC-13-W	Battery tube 10 batteries white	1 pcs/Carton	100 pcs/Carton	
/	ABC-21-W	Solar power supply	1 pcs/Carton	1 pcs/Carton	
	ABC-21-S				

REMOTE CONTROLS

POWER SUPPLIES

PARTS LIST
Ultimate Panel Blind

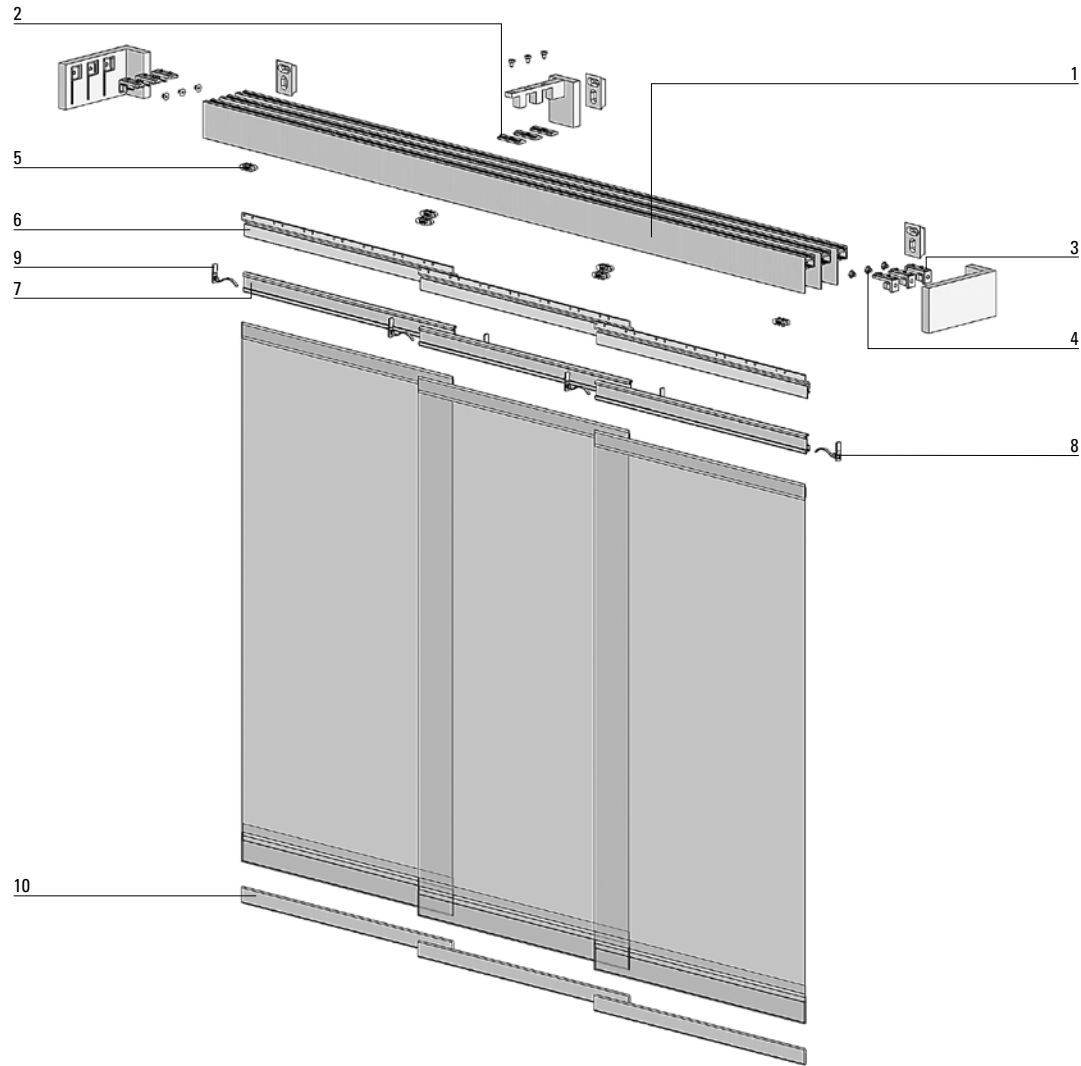

PARTS LIST
Ultimate Panel Blind
bracket configurations

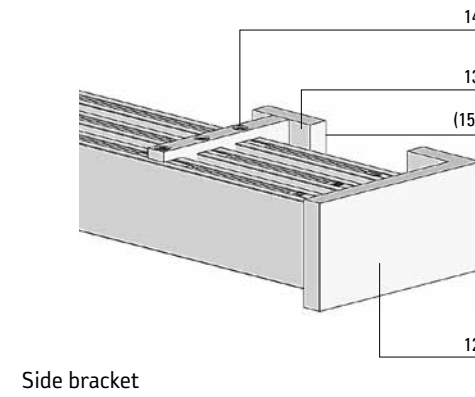

Side bracket

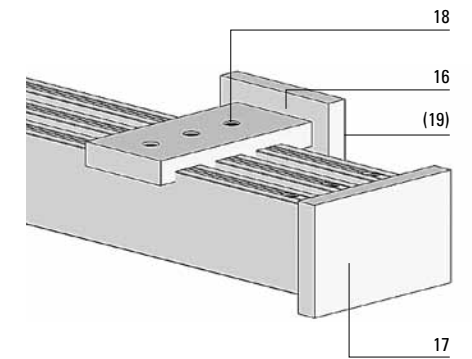

Wall bracket with end cap

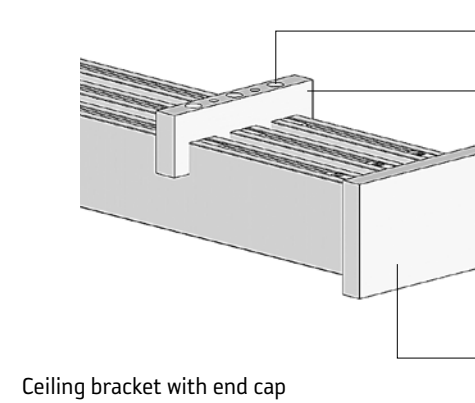



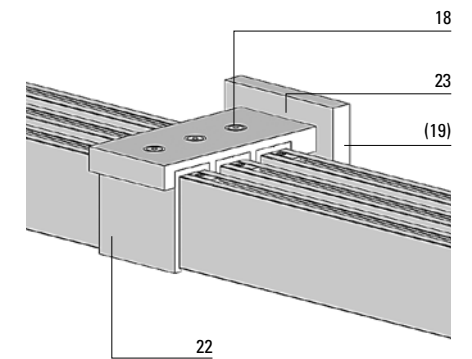







Ceiling bracket with end cap











Rail connector

ULTIMATE PANEL BLIND

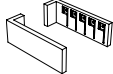



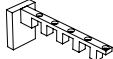





Pos	Code	Description	Inner Carton	Outer Carton	
1	PTU-01-B PTU-01-S-4	Ultimate Panel Blind rail L-type 400cm bright Ultimate Panel Blind rail L-Type 360cm satin	40 mtr/Carton 43,2 mtr/Carton	40 mtr/Carton 43,2 mtr/Carton	
2	PTU-23	Insert plate for rail	250 pcs/Carton	2000 pcs/Carton	
3	PTU-26	Insert plate for side bracket	250 pcs/Bag	2000 pcs/Carton	
4	PTU-28	Screw M4x6 DIN 7991 for PTU-26	250 pcs/Bag	2000 pcs/Carton	
5	PTC04-W	Runner white	500 pcs/Bag	5000 pcs/Carton	
6	PTC20VH-S	Sliding profile PVC 300cm grey	120 mtr/Carton	120 mtr/Carton	
7	PTC28V-S	Panel profile with velcro 300cm grey	120 mtr/Carton	120 mtr/Carton	
8	PTC26VL-S	End cap velcro left grey	500 pcs/Bag	5000 pcs/Carton	
9	PTC26VR-S	End cap velcro right grey	500 pcs/Bag	5000 pcs/Carton	
10	PTB25-W-300	Bottom rail 300cm white	108 mtr/Carton	108 mtr/Carton	

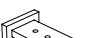









ULTIMATE RAIL







SLIDING PROFILE

Pos	Code	Description	Inner Carton	Outer Carton	
12	PTU-07-B PTU-07-S	Side bracket set 2-way left and right bright Side bracket set 2-way left and right satin	5 set/Carton 5 set/Carton	50 set/Carton 50 set/Carton	
12	PTU-08-B PTU-08-S	Side bracket set 3-way left and right bright Side bracket set 3-way left and right satin	5 set/Carton 5 set/Carton	50 set/Carton 50 set/Carton	
12	PTU-09-B PTU-09-S	Side bracket set 4-way left and right bright Side bracket set 4-way left and right satin	5 set/Carton 5 set/Carton	50 set/Carton 50 set/Carton	
12	PTU-10-B PTU-10-S	Side bracket set 5-way left and right bright Side bracket set 5-way left and right satin	5 set/Carton 5 set/Carton	50 set/Carton 50 set/Carton	
13	PTU-11-B PTU-11-S	Middle bracket 2-way bright Middle bracket 2-way satin	10 pcs/Carton 10 pcs/Carton	100 pcs/Carton 100 pcs/Carton	
13	PTU-12-B PTU-12-S	Middle bracket 3-way bright Middle bracket 3-way satin	10 pcs/Carton 10 pcs/Carton	100 pcs/Carton 100 pcs/Carton	
13	PTU-13-B PTU-13-S	Middle bracket 4-way bright Middle bracket 4-way satin	10 pcs/Carton 10 pcs/Carton	100 pcs/Carton 100 pcs/Carton	
13	PTU-14-B PTU-14-S	Middle bracket 5-way bright Middle bracket 5-way satin	10 pcs/Carton 10 pcs/Carton	100 pcs/Carton 100 pcs/Carton	
14	PTU-29	Inbus screw M4x6 DIN7984 for PTU-11 till PTU-14	200 pcs/Carton	2000 pcs/Carton	
15	PTU-25	Wall fixing plate side bracket	100 pcs/Bag	1000 pcs/Carton	

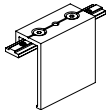
SIDE BRACKET

Pos	Code	Description	Inner Carton	Outer Carton	
16	PTU-03-B	Wall bracket 2-way bright	10 pcs/Carton	100 pcs/Carton	
	PTU-03-S	Wall bracket 2-way satin	10 pcs/Carton	100 pcs/Carton	
16	PTU-04-B	Wall bracket 3-way bright	10 pcs/Carton	100 pcs/Carton	
	PTU-04-S	Wall bracket 3-way satin	10 pcs/Carton	100 pcs/Carton	
16	PTU-05-B	Wall bracket 4-way bright	10 pcs/Carton	100 pcs/Carton	
	PTU-05-S	Wall bracket 4-way satin	10 pcs/Carton	100 pcs/Carton	
16	PTU-06-B	Wall bracket 5-way bright	10 pcs/Carton	100 pcs/Carton	
	PTU-06-S	Wall bracket 5-way satin	10 pcs/Carton	100 pcs/Carton	
17	PTU-36-B	End cap singular bright	10 pcs/Carton	100 pcs/Carton	
	PTU-36-S	End cap singular satin	10 pcs/Carton	100 pcs/Carton	
17	PTU-19-B	End cap set 2-way bright	5 set/Carton	50 set/Carton	
	PTU-19-S	End cap set 2-way satin	5 set/Carton	50 set/Carton	
17	PTU-20-B	End cap set 3-way bright	5 set/Carton	50 set/Carton	
	PTU-20-S	End cap set 3-way satin	5 set/Carton	50 set/Carton	
17	PTU-21-B	End cap set 4-way bright	5 set/Carton	50 set/Carton	
	PTU-21-S	End cap set 4-way satin	5 set/Carton	50 set/Carton	
17	PTU-22-B	End cap set 5-way bright	5 set/Carton	50 set/Carton	
	PTU-22-S	End cap set 5-way satin	5 set/Carton	50 set/Carton	
18	PTU-27	Inbus screw M4x6 DIN912 for PTU-03 till PTU-06	250 pcs/Bag	2000 pcs/Carton	
19	PTU-24	Wall fixing plate wall bracket	100 pcs/Bag	1000 pcs/Carton	

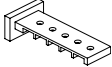
Pos	Code	Description	Inner Carton	Outer Carton	
20	PTU-15-B	Ceiling bracket 2-way bright	10 pcs/Carton	100 pcs/Carton	
	PTU-15-S	Ceiling bracket 2-way satin	10 pcs/Carton	100 pcs/Carton	
20	PTU-16-B	Ceiling bracket 3-way bright	10 pcs/Carton	100 pcs/Carton	
	PTU-16-S	Ceiling bracket 3-way satin	10 pcs/Carton	100 pcs/Carton	
20	PTU-17-B	Ceiling bracket 4-way bright	10 pcs/Carton	100 pcs/Carton	
	PTU-17-S	Ceiling bracket 4-way satin	10 pcs/Carton	100 pcs/Carton	
20	PTU-18-B	Ceiling bracket 5-way bright	10 pcs/Carton	100 pcs/Carton	
	PTU-18-S	Ceiling bracket 5-way satin	10 pcs/Carton	100 pcs/Carton	
17	PTU-36-B	End cap singular bright	10 pcs/Carton	100 pcs/Carton	
	PTU-36-S	End cap singular satin	10 pcs/Carton	100 pcs/Carton	
17	PTU-19-B	End cap set 2-way bright	5 set/Carton	50 set/Carton	
	PTU-19-S	End cap set 2-way satin	5 set/Carton	50 set/Carton	
17	PTU-20-B	End cap set 3-way bright	5 set/Carton	50 set/Carton	
	PTU-20-S	End cap set 3-way satin	5 set/Carton	50 set/Carton	
17	PTU-21-B	End cap set 4-way bright	5 set/Carton	50 set/Carton	
	PTU-21-S	End cap set 4-way satin	5 set/Carton	50 set/Carton	
17	PTU-22-B	End cap set 5-way bright	5 set/Carton	50 set/Carton	
	PTU-22-S	End cap set 5-way satin	5 set/Carton	50 set/Carton	
21	PTU-30	Inbus screw M4x12 DIN912 for PTU-15 till PTU-18	250 pcs/Bag	8000 pcs/Carton	

Pos	Code	Description	Inner Carton	Outer Carton	
22	PTU-35-B	Rail connector bright	10 pcs/Carton	100 pcs/Carton	
	PTU-35-S	Rail connector satin	10 pcs/Carton	100 pcs/Carton	
23	PTU-31-B	Wall bracket 2-way for rail connector bright	10 pcs/Carton	100 pcs/Carton	
	PTU-31-S	Wall bracket 2-way for rail connector satin	10 pcs/Carton	100 pcs/Carton	
23	PTU-32-B	Wall bracket 3-way for rail connector bright	10 pcs/Carton	100 pcs/Carton	
	PTU-32-S	Wall bracket 3-way for rail connector satin	10 pcs/Carton	100 pcs/Carton	
23	PTU-33-B	Wall bracket 4-way for rail connector bright	10 pcs/Carton	100 pcs/Carton	
	PTU-33-S	Wall bracket 4-way for rail connector satin	10 pcs/Carton	100 pcs/Carton	
23	PTU-34-B	Wall bracket 5-way for rail connector bright	10 pcs/Carton	100 pcs/Carton	
	PTU-34-S	Wall bracket 5-way for rail connector satin	10 pcs/Carton	100 pcs/Carton	
18	PTU-27	Inbus screw M4x6 DIN912 for PTU-03 till PTU-06	250 pcs/Bag	2000 pcs/Carton	
19	PTU-24	Wall fixing plate wall bracket	100 pcs/Bag	1000 pcs/Carton	

COLLECTIONS

Coulisse offers a wide range of fabrics that either were especially designed for panel blind or are part of the roller blind fabric family and very suitable for the application in panel blinds. The range varies from transparent plain fabrics, Ultimate Jacquards, Lasercuts and several Trevira CS varieties to elegant screen fabrics.

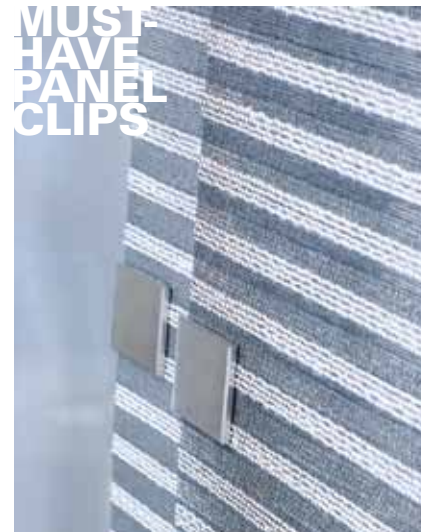

UNIQUE LASER CUT FABRICS



LUXURIOUS JACQUARDS



DESIGN CORD AND CHAIN WEIGHTS

DOCUMENTATION

Please visit the Coulisse customer portal for the following documentation. If you do not have a login code for the portal please contact your contact at Coulisse.

- **Assembly manual**
- **Calculation sheet**

SERVICE AND SUPPORT

For more information regarding this product or other Coulisse products, please visit www.coulisse.com or login to the Coulisse customer portal. If you do not have a login account or if you would like more information about technical and/or marketing support please contact your contact at Coulisse.

COMPANY PROFILE

Window decorations are more than just products: they are an expression of style and individuality. This has been Coulisse's vision since its establishment in 1992, and it has helped to make the business a leading supplier of both ready-made window-decoration products for DIY retailers and components for assemblers and wholesalers of made-to-measure products. Coulisse offers its clients a comprehensive range of products, from wooden Venetian blinds to roller blinds and from vertical blinds to pleated blinds. Thanks to a constant focus on innovation, creativity and flexibility, Coulisse is even capable of starting new trends and anticipating specific client needs. Coulisse products are developed in Enter and manufactured throughout the world.





Coulisse B.V. Vonderweg 48 7468 DC Enter The Netherlands
T +31 547 85 55 55 F +31 547 85 55 50 info@coulisse.com www.coulisse.com

coulisse[®]